

# SCX SERIES

Commercial Lighting

**WESTGATE**  
THE FUTURE IS HERE...AND IT'S QUITE BRIGHT!

SCX-6FT-60W-MCT4-D-LUV



Selection:



Custom:



Customer Name: \_\_\_\_\_  
Project Name: \_\_\_\_\_  
Note: \_\_\_\_\_ | Type: \_\_\_\_\_

Linear Lighting can customize your desired length, look, and color temperature to be suspended, Ideal for Storage rooms, Offices Conference rooms, Retail.

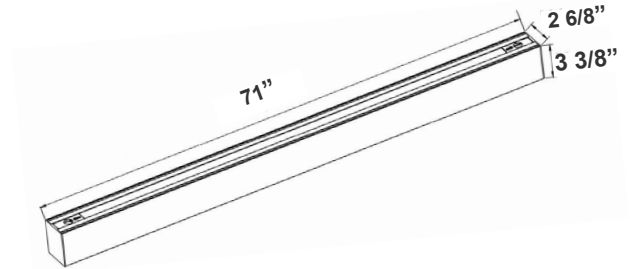

71"(L) x 2 6/8"(W) x 3 3/8"(H)

## Features

- LED Superior Architectural Lights
- Seamless Linkable Linear Lighting System
- Polished Aluminum Louver Lens-Direct (DOWN) Lighting
- Lens Type: Polished Aluminum Louver Lens
- MCT: Multi Color Temperature (Selectable with Switch Inside Fixture)
- Optional Recessed & Wall Mounting Kits Available

## Technical Specifications

### Electrical:

- Voltage: 120-277VAC 50/60Hz
- Wattage: 60W
- Power Factor: >0.95
- Total Harmonic Distortion: ≤ 20 %

### Mechanical:

- Low Profile Modern Design
- Aluminum Housing With Matte White Finish
- Custom Colors Available
- Lens Snaps into Housing
- Lens Type: Polished Aluminum Louver Lens
- Mounting Options: Surface, Suspended, Wall, Recessed
- IP Rating: IP54
- Operating Temperature: -13°F~104°F
- 5-Year Warranty

### Lighting:

- Dimmable: 0~10V Dimming
- Total Lumens: 6658LM/ 6724LM/ 7046LM/ 7102LM
- Color Temperatures: 3000K/3500K/4000K/5000K
- Multi-CCT(Selectable Switch Inside Fixture)
- Color Rendering Index: CRI ≥ 80
- Up Light Option Available
- 50,000 Hours Rated Life
- Beam Angle: 104.8°(H) x 100.5°(V)

### Applications:

- Ideal for offices, hotels, corridors, saloons, libraries, meeting rooms, conference halls, and the best solution for modern lighting solutions
- It can be used in any indoor applications

### Other Models:

• 20W | 2390LM | SCX-2FT-20W-MCT4-D-LUV • 30W | 3551LM | SCX-3FT-30W-MCT4-D-LUV • 40W | 4710LM | SCX-4FT-40W-MCT4-D-LUV • 80W | 9420LM | SCX-8FT-80W-MCT4-D-LUV



Phone: (877) 805-2252 | Fax: (877) 805-2252  
www.westgateimg.com | www.westgatecontrols.co



WG-Z8-ZB-22

## Photometrics: SCX-6FT-MCT4-D-LUV

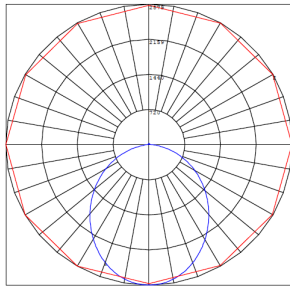
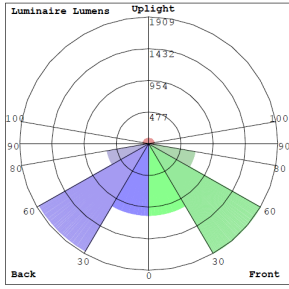

BUD Rating: B3-U3-G1

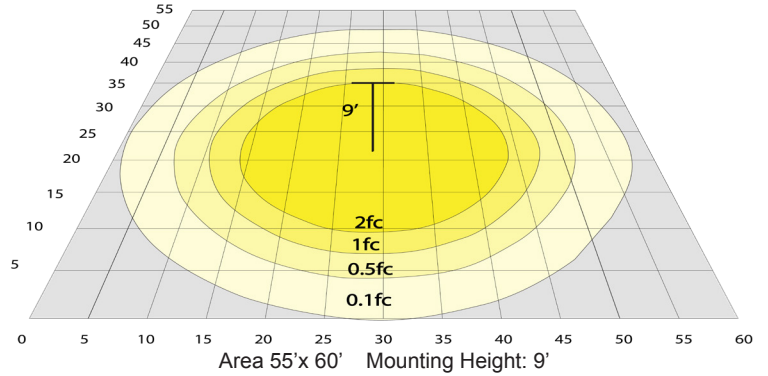

## Other Views:

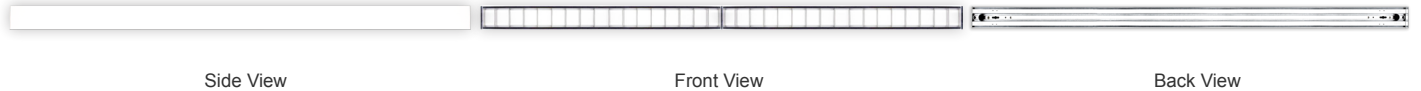

## Performance Table: SCX-6FT-MCT4-D-LUV

MODEL NO.	Wattage	Voltage	Lumens	Color Temp.	BUG Rating	LPW
SCX-6FT-60W-MCT4-D-LUV	60W	120~277V	6658LM	3000K	B3-U3-G1	111
			6724LM	3500K		112
			7046LM	4000K		117
			7102LM	5000K		118

## Sample Ordering

Model	Size	Wattage	Color Temp.	Feature	Lens
SCX	6FT	60W	MCT4	D	LUV

## Accessories:

- Blank = No Option For Accessories
- SCL-CS = FOR UP TO 6FT FIXTURES Adjustable 6ft 1/16" Aircraft Cable Suspension Kit with Canopy for Ceiling or T-Bar
- SCL-CS3 = FOR 8FT FIXTURES Adjustable 6ft 1/16" Aircraft Cable Suspension Kit with Canopy for Ceiling or T-Bar
- SCL-6FT-SJTW18/5 = 6ft White Cord, SJTW 18 AWG 5-Conductor (Black, White, Green + Purple & Gray for 0-10V Dimming)
- SCL-6FT-SJTW18/5-100FT = 100ft Roll of White Cord, SJTW 18 AWG 5-Conductor (Black, White, Green + Purple & Gray for 0-10V Dimming)
- SCL-6FT-SJTW18/5-100FT-BK = 100ft Roll of Black Cord, SJTW 18 AWG 5-Conductor (Black, White, Green + Purple & Gray for 0-10V Dimming)
- SCL-6FT-SJTW18/6-100FT = 100ft Roll of Black Cord, SJTW 18 AWG 6-Conductor (Black, White, Green + Purple & Gray for 0-10V Dimming + Red for Backup Inverter)
- SCL-AH = Heavy-Duty Auxiliary Hook for Up To 1/16" Aircraft Cable
- SCL-ASC-500FT = 1/16" 500 ft. Steel Aircraft Cable Suspension

## Factory-Installed Options:

- Blank = No Option For Accessories
- OPT-HBC-125BS-WH = 10FT, 15A, 125V, 18/3 STR, WHT

\* More Factory-Installed Options Refer to page 4

## SUSPENDED MOUNTING ACCESSORIES (NOT INCLUDED)



SCL-CS



SCL-CS3



SCL-6FT-SJTW18/5-100FT  
SCL-6FT-SJTW18/6-100FT



SCL-6FT-SJTW18/5-100FT-BK



SCL-ASC-500FT



SCL-AH



SCL-ASC-500FT



SCL-6FT-SJTW18/5

## FACTORY-INSTALLED OPTIONS:



OPT-HBC-125BS-WH

## Example:

1. SCX-6FT-60W-MCT4-D-LUV
2. SCX-6FT-60W-MCT4-D-LUV  
OPT-HBC-125BS-WH

(For SCX 60W MCT4 fixture 120-277V)

(For SCX 60W MCT4 fixture 120-277V)  
(10FT, 15A, 125V, 18/3 STR, WHT)



## MOUNTING AND MODULES OPTIONS:

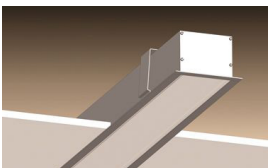

Recessed Mounted  
(Flanged)



Surface Mounted

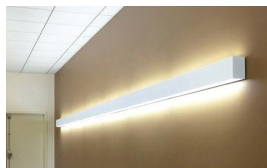

Wall Mounted



Suspended

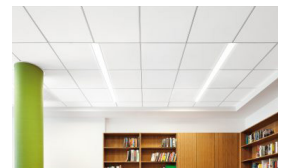

T-Bar Installation

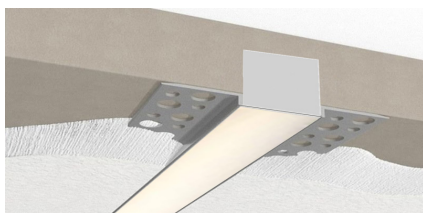

Flangless Recessed Mounted  
(Mud-In)

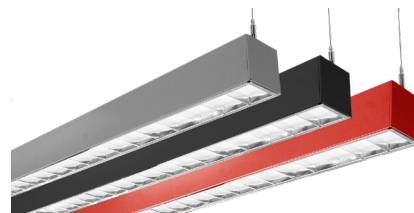

Color of Your Choice



## MOUNTING OPTIONS:

### FLANGLSS RECESSED INSTALLATION IN WOOD CEILING

No additional accessories required.

Make recessed preparations by installing a horizontal plank of wood on top of the wood ceiling at a recessed height of 3 3/8".

Screw and anchor kit provided with each fixture can be used to fasten the top of the fixture to the wood plank through the holes on top of the fixture.

You can also install vertical wood boards on top of the ceiling at the edge of the opening and open the fixture and put screws through the side of the fixture housing to fasten it to the wood boards.



### SUSPENSION ROD KITS (SET OF 2)

Model	SIZE
SCL-RS-12	12 IN
SCL-RS-18	18 IN
SCL-RS-24	24 IN
SCL-RS-36	36 IN
SCL-RS-48	48 IN

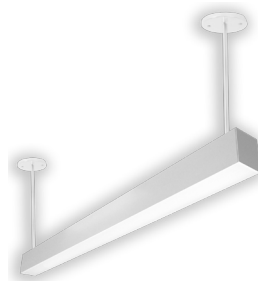

### WALL MOUNTING

Model	DESCRIPTION
OPT-SCX-WM-6FT	Install this optional wall mounting brackets on the back of the fixture. Connection cables will enter the fixture through one of these wall-mounting brackets. On your purchase order, please specify the position of where your wire entry from the wall.

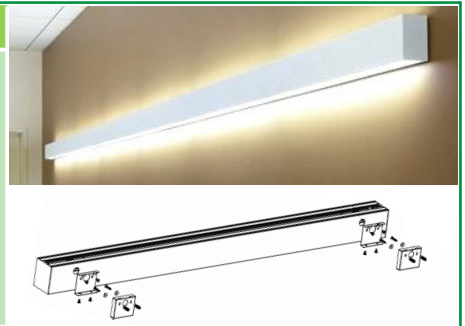

### RECESSED MOUNT WITH FLANGE

Model	DESCRIPTION
OPT-SCX-FMR-6FT	Order this option and the fixture will be equipped with a 1/2" wide flange on four sides. Advanced design toggle-style brackets will also be provided, to adjust and hold the fixture against drywall or other hard ceilings from the top. When linking to another fixture or corner module, call us or send a copy of your plan along with your PO, and flanges will be removed on those ends that need to make a seamless connection.

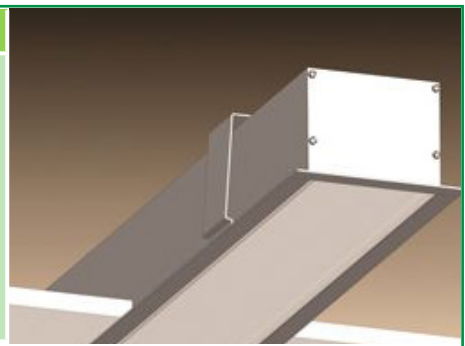

### LINKING

Model	DESCRIPTION
OPT-SCX-LINKWIRING	Fixtures are equipped with pre-installed linking brackets and accessories and only need to be wired together. to receive a fixture prewired for linking, order the option below for each link to another fixture or a corner module.





## FLANGELESS RECESS MOUNT IN DRYWALL (MUD-IN)

Model	DESCRIPTION	
OPT-SCX-MIF-3FT	Order this option and the fixture will be equipped with mud-in brackets on all four sides, mounted at 1/16" from the lens surface (specify if other spacing is needed). Advanced design toggle-style brackets will also be provided, to adjust and hold the fixture against the drywall ceiling from the top. When linking to another fixture or corner fixture module call us or send a copy of your plan along with your PO and flanges will be removed on those end that needs to make a seamless connection.	

## SURFACE MOUNTING

<p>No additional accessories required.</p> <p>Screw and anchor kit provided with each fixture can be used to fasten the fixture directly to the hard surface through the holes on top of the fixture.</p>	
---	--



## FACTORY-INSTALLED OPTIONS:

### COLOR OF YOUR CHOICE

Model	DESCRIPTION
OPT-SCX-CLR-6FT	Add this option and specify your desired color on your purchase order or provide a swatch to match. For painted flanged fixture or optional rod, mounting set please also add the relevant option below for each fixture.
OPT-SCX-CLR-FRM	This is a painted flanges option.
OPT-SCX-CLR-RODSET	This is a painted rod set option.

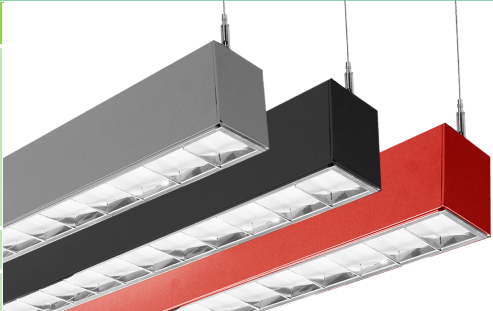

### INDIRECT (UP) LIGHTING

Model	WATTS	LUMENS	COLOR TEMP	SIZE
OPT-SCX-ULM-6FT-24W-MCT4	24W	2400LM 2472LM 2520LM 2592LM	3000K 4000K 5000K 6000K	6FT
OPT-SCX-ULM-BU	Indirect (up) light with blue color			
OPT-SCX-ULM-GR	Indirect (up) light with green color			



### EMERGENCY BATTERY BACKUP

Model	DESCRIPTION
OPT-EM-CM1INT	This is an option for a 90-minute backup battery installation. If you need to order this series for the fixture, please have your purchase order ready and call us or specify on the order which fixture to install this option and the test button.

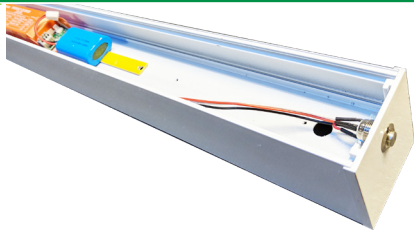

### BI-LEVEL MOTION SENSOR

Model	DESCRIPTION
OPT-SCX-SEN2US	This option installs an advanced motion sensor that will turn the lights on when the area is occupied. When the area is cleared, after a preset hold time of 5 sec or more the lights are dimmed to a standby level of 30% or more. If still no motion is detected, after the standby period, the light is turned off. All setting is programmable with a remote control.
OPT-WEC-3RC	This is an optional remote control for sensor.
OPT-SEN-SCX-2MRLV-5	This is a programmable microwave Bi-Level sensor.
OPT-SEN-2US-DAYLIGHT	It is an ultrasonic Bi-Level Dimming Daylight sensor option for internal installation inside the fixture. (Remote not needed)

